

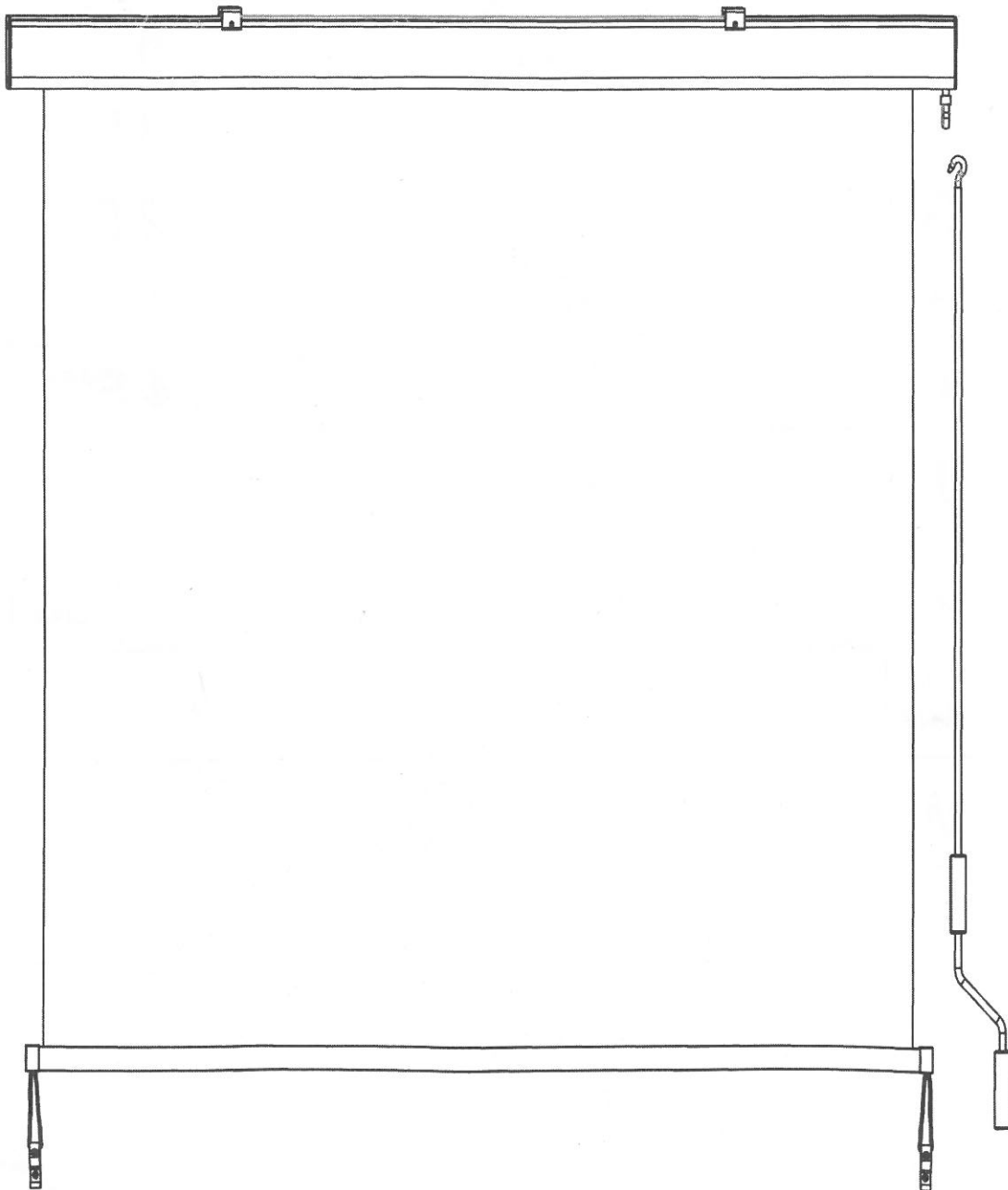

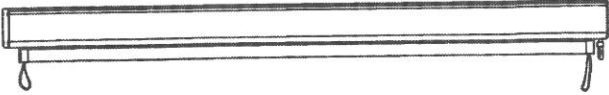









Aufbauanleitung

Senkerechtmarkise

16800819 / I-6849-JHS



A		1 Stk.
B		1 Stk.
C		2 Stk.
D		2 Stk.
E		4 Stk.
F		4 Stk.
G		2 Stk.
H		4 Stk.
I		4 Stk.
J		1 Stk.
K		8 Stk.
L		4 Stk.
M		4 Stk.

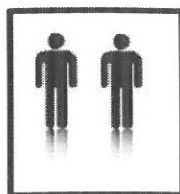

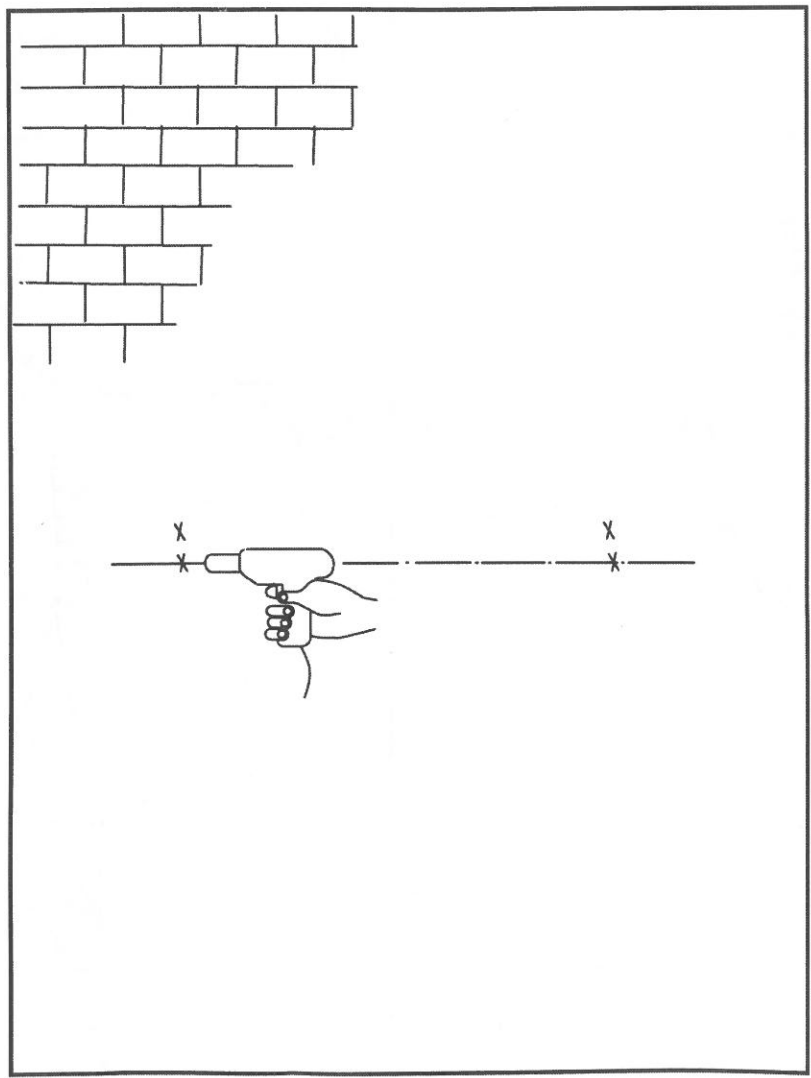
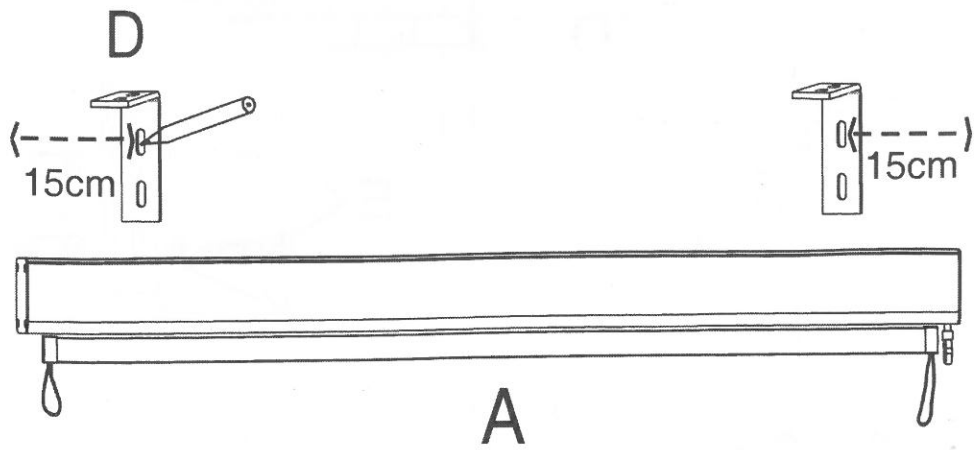

1

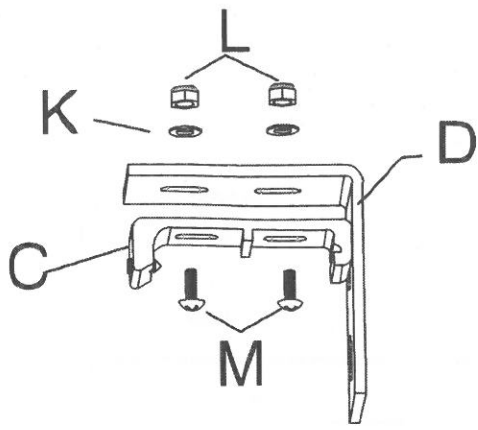

2

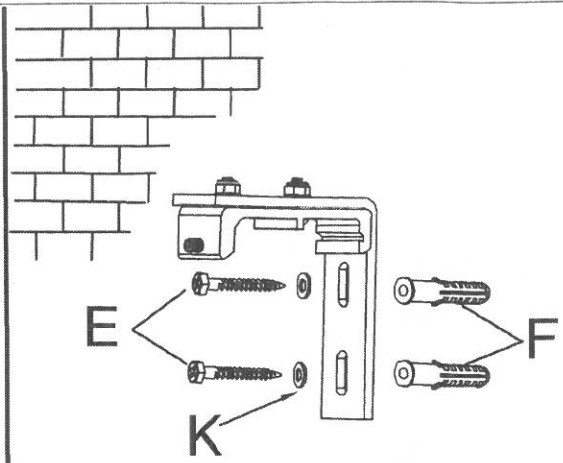
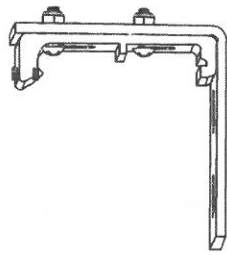

3

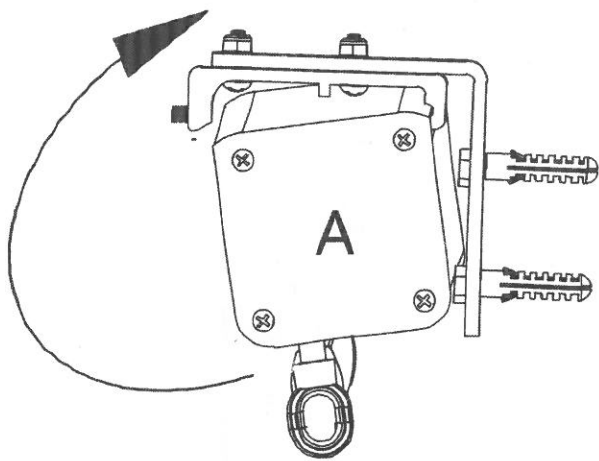
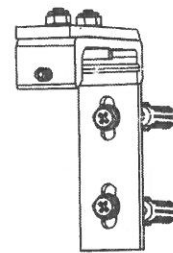

4

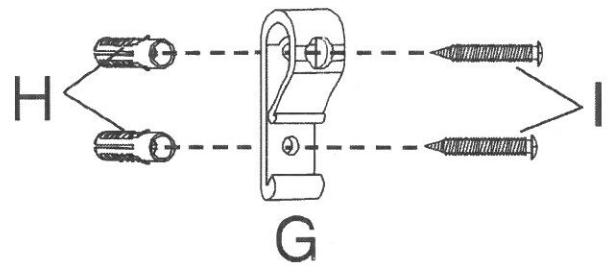
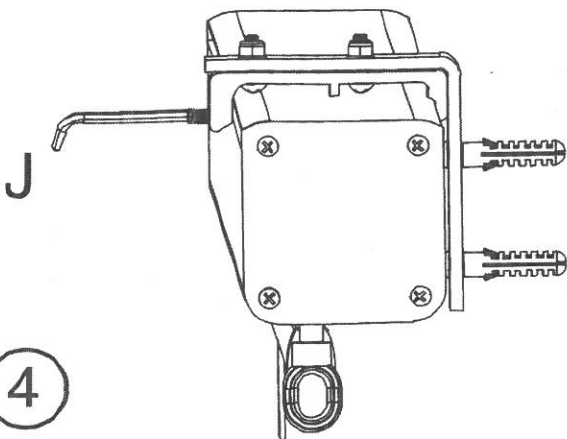

5



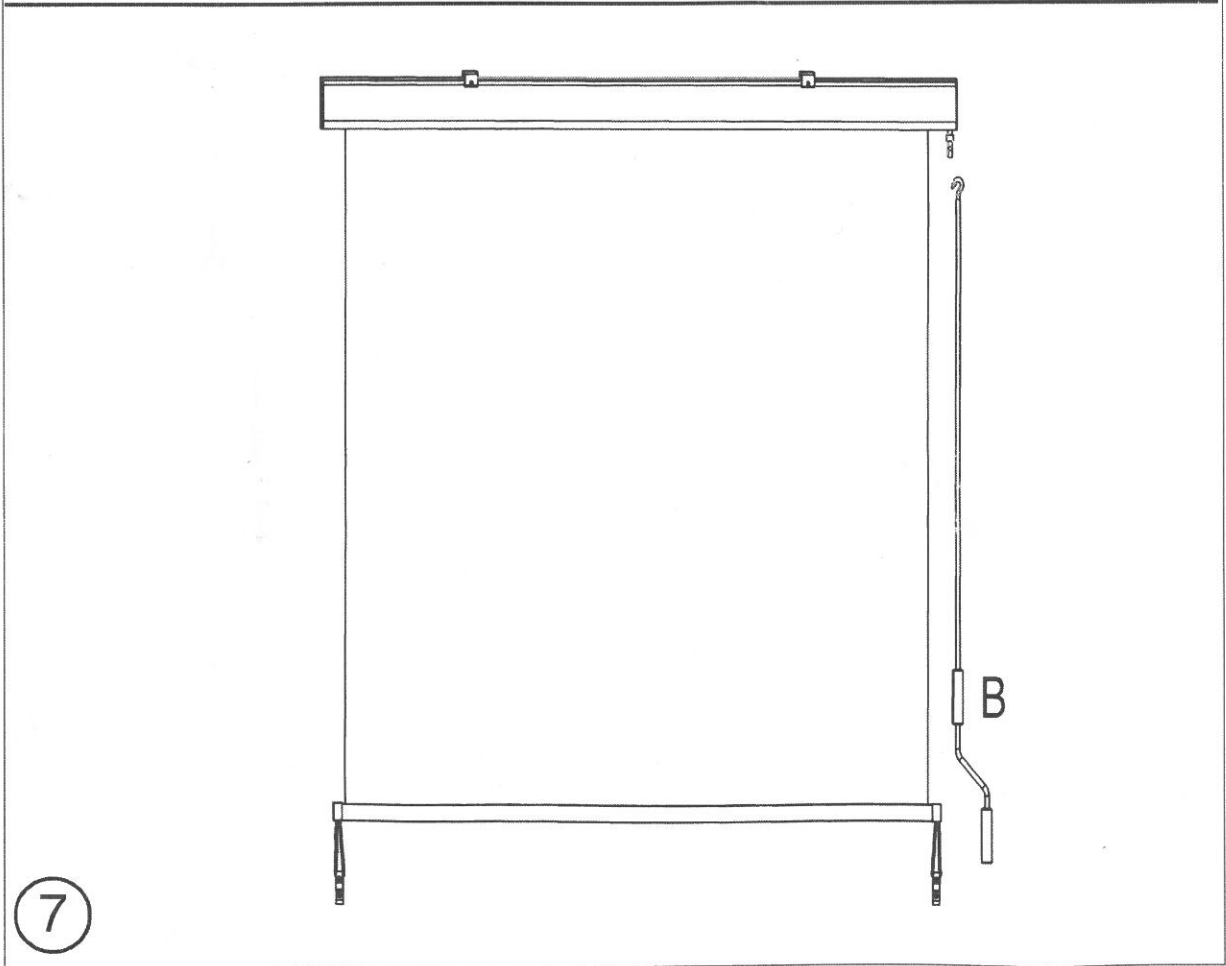
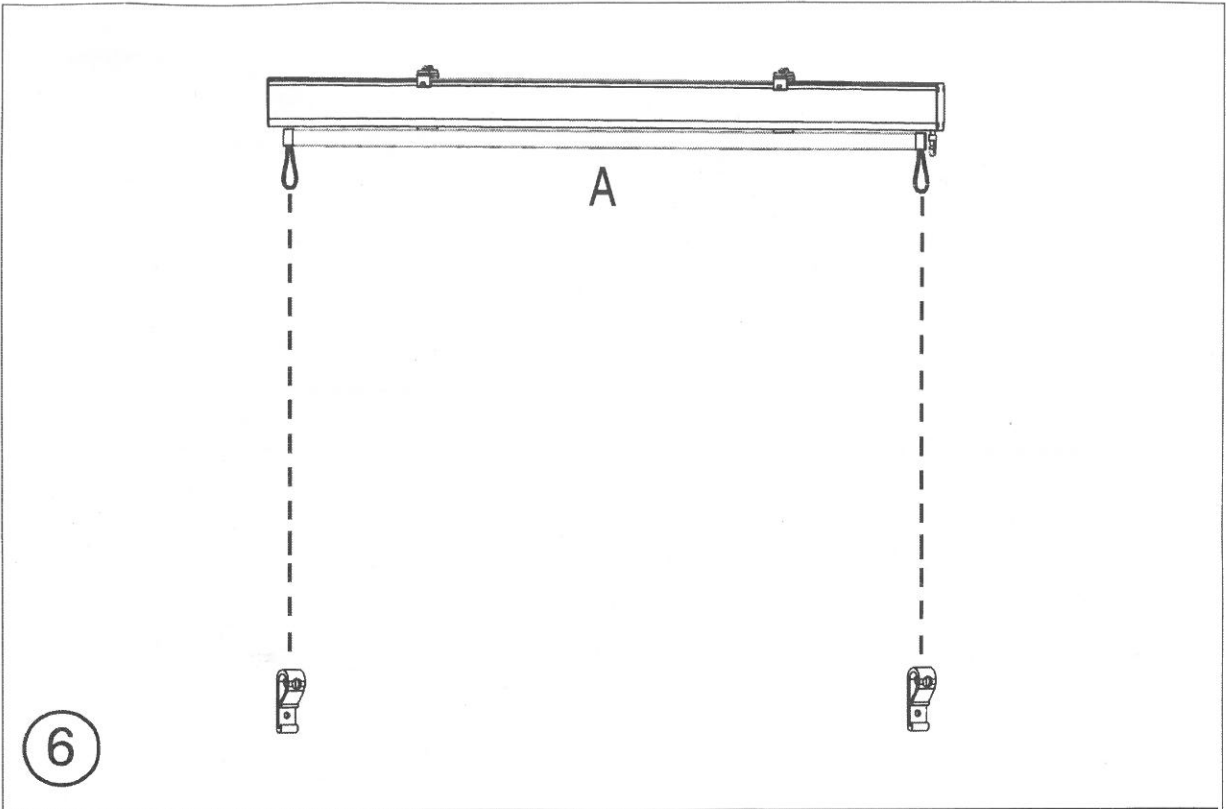

Hergestellt für:
Thomas Philipps GmbH & Co. KG
Osnabrücker Str. 21, D-49143 Bissendorf